USER MANUAL

**MODEL NUMBER:
FI-20NT
FI-20NTK
AND RELATED UNITS**

**20 Gallon Air Operated Portable Foam
Equipment**

English (Original Instructions)

READ ALL INSTRUCTIONS BEFORE OPERATING EQUIPMENT



WARNING



Read this manual completely and understand the machine before operating or servicing it.

- Read all instructions before installing or operating unit.
- Always wear appropriate personal protective equipment (PPE) when operating or servicing unit.
- Always follow all chemical safety precautions and handling instructions provided by the chemical manufacturer and Material Safety Data Sheet (MSDS).
- Never point the discharge wand at yourself, another person, or any object you do not want covered in chemical.
- Always depressurize unit after use (as described in the After Use Instructions). Always store unit depressurized, with the discharge ball valve in the closed position.
- Do not exceed an incoming air pressure of 100 psi (7 bar).
- Do not exceed a fluid temperature of 180°F (82°C).
- Only use clean and dry air. Air must be filtered and free of moisture or pump life will be diminished. If needed, install an air dryer before unit.
- Do not use an air lubricator before the unit.

PROTECT THE ENVIRONMENT

Please dispose of packaging materials, old machine components, and hazardous fluids in an environmentally safe way according to local waste disposal regulations.



Always remember to recycle.

*Specifications and parts are subject to change without notice.

Specifications:

Hose	30 feet reinforced hose, 3/4 inch inside diameter (9 meters reinforced hose, 19 mm inside diameter)
Tank Capacity	20 gallons (75.7 liters)
Foam Output	20 to 45 gallons/minute (75 to 170 liters/minute)
Foam Distances	25 to 30 feet (7 to 9 meters)
Liquid Temperature	40°F to 180°F (4.4°C to 82°C)

Dimensions:

Length	22 in (559 mm) approximately
Width	19 in (483 mm) approximately
Height	47 in (1194 mm) approximately
Weight, including discharge hose and wand: (Empty)	57 lbs (26 kg) approximately

Requirements:

Compressed Air Source Requirements: Air regulator (R25) is factory set at 50 psi (3.4 bar). Operating range is 40 to 80 psi (3 to 5 bar) with 5 to 10 CFM (141.64 to 283.30 l/min).

Chemical Requirements: Follow all instructions from chemical manufacturer and Material Safety Data Sheet (MSDS).

Air Operated Double Diaphragm Pump Models Offered:

GP14T: Polypropylene body with Teflon diaphragm

GP14K: Kynar body with Teflon diaphragm

Acceptable Products:

Alkaline cleaners, Caustic cleaners, Sanitizers, Acids, D-Limonene, and Chlorine

DO NOT USE: All hydrocarbons

READ ALL INSTRUCTIONS BEFORE OPERATING EQUIPMENT

Operation Instructions:

1. Follow all instructions from chemical manufacturer. Fill the tank with water and the advised percentage of chemical concentrate.
 2. With ball valve (HV60) in the closed position, plug an air line into the air fitting (AP25).
 3. Slowly open the ball valve (HV60) completely to begin foaming.
 4. Adjust the needle valve (NV14Y) to desired wetness or dryness of foam following the steps below:
 - a. Close needle valve completely in clockwise direction.
 - b. Open needle valve in counter-clockwise direction 3 complete turns.
 - c. Continue to open valve in ¼ turn increments allowing 30 seconds between adjustments until proper consistency of foam is achieved.
- If needle valve (NV14Y) valve is open too far, the pump (GP14T, GP14K) will cycle improperly due to lack of air pressure. If this occurs, reset needle valve as described in Operation Instruction #4.
 - Make sure proper foaming chemical and concentration is being used.
 - If air passes through the pump (GP14T, GP14K) without cycling, the pump needs to be replaced.
 - If foam solution backs up into air regulator bowl (ABR25), the check valve (CV38) needs to be replaced.
 - If foam comes out wet, no matter where the needle valve (NV14Y) is positioned, the check valve (CV38) may need to be replaced.
 - Check for proper air pressure on air gauge (AG100). Air regulator (R25) is factory set at 50 psi (3.4 bar). Operating range is 40 to 80 psi (3 to 5 bar) with 5 to 10 CFM (141.64 to 283.30 l/min).
 - If the unit foams at a reduced pressure:
 - o Check the air compressor supplying the unit. If the pressure is less than 40 psi, turn the foam unit off until the compressor can catch up.
 - o If the air supply is 50 psi (4.14 bar) or above, check the AG100, which should read near 50 psi (4.14 bar). If the AG100 is more or less than 50 psi (4.14 bar), adjust the pressure by turning the knob on the top of the air regulator (R25).
 - o If both of the above are okay, the stainless steel mixing mesh (SS-MESH) could be plugged. Remove and clean it by following the instructions below:
 1. Be sure the foam unit is not plugged into an air supply and be sure to relieve all stored pressure in the unit by having the ball valve (HV60) in the open position.
 2. Remove the stainless adaptor (SSA12) from the tee fitting (SST12HB38).
 3. Remove the screen and the mixing mesh from inside the tee fitting (SST12HB38).
 4. Clean any particles from the mixing mesh and the screen.
 5. Replace the mixing mesh and then the screen into the back of the tee and screw the stainless adaptor back into the tee. It is recommended to use a pipe thread sealant when reinstalling the stainless adaptor back into the tee fitting (SST12HB38). If the mixing mesh has a lot of foreign particles in it, make sure the strainer (STR38-IL) is still in place.

After Use Instructions:

1. Flush the unit with fresh water for 5 minutes.
2. Disconnect the air line from the air fitting (AP25) and relieve any remaining pressure in the system by opening the discharge ball valve (HV60).
3. Close the ball valve (HV60) after all pressure has been relieved from the system. Store the unit with the discharge ball valve (HV60) in the closed position.

Maintenance Instructions:

To keep your portable foam unit operating properly, periodically perform the following maintenance procedures:

Note: Before performing any maintenance, ensure that the unit has been disconnected from the air/water supply and depressurized according to the "After Use Instructions" above.

- Check the air pump (GP14T, GP14K) for wear and leaks.
- Inspect hoses for leaks or excessive wear. Make sure all hose clamps are in good condition and properly secured.
- Replace filter (AFR25) in air regulator (R25) as needed.
- Check the suction tube, screen, and strainer (STR-38-IL) for debris and clean as needed.
- Drain compressor tank on a regular basis to ensure proper operation of pump.

Troubleshooting Instructions:

- Check to ensure the discharge hose is uncoiled properly, and that there are no kinks that could obstruct fluid flow.
- Check air regulator bowl (ABR25) for debris such as water, oil, or rust particles. Clean by unthreading the air regulator bowl from the air regulator (R25).
- Check for plugged strainer (STR38-IL). Replace strainer if necessary. Strainer must be used.

READ ALL INSTRUCTIONS BEFORE OPERATING EQUIPMENT

TANK ASSEMBLY ITEM NUMBER: TANK-20N-A

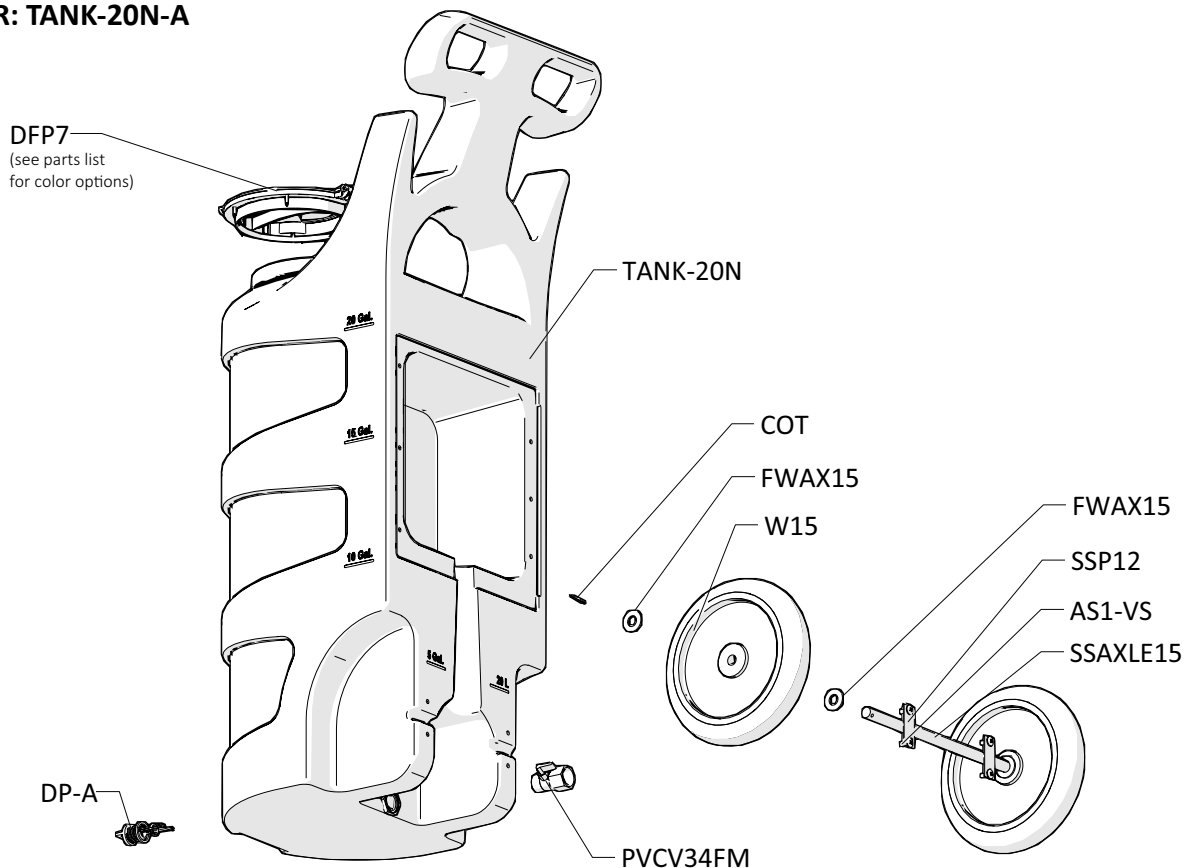

HOSE AND WAND ASSEMBLY ITEM NUMBER: SSWA38-HA30

ZERO TIP FOAM WAND ASSEMBLY ITEM NUMBER: SSWA38

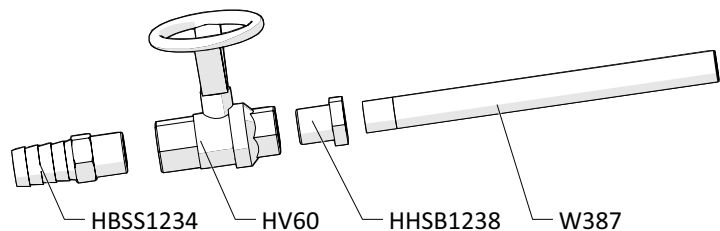

30 ft (9 m) HOSE ASSEMBLY ITEM NUMBER: H34-30

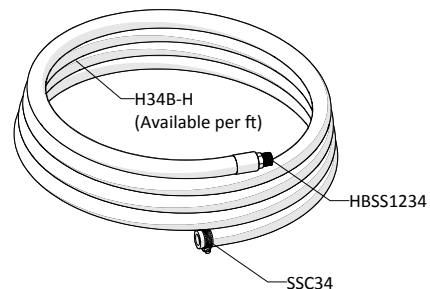

READ ALL INSTRUCTIONS BEFORE OPERATING EQUIPMENT

PLATE ASSEMBLY - Inside View

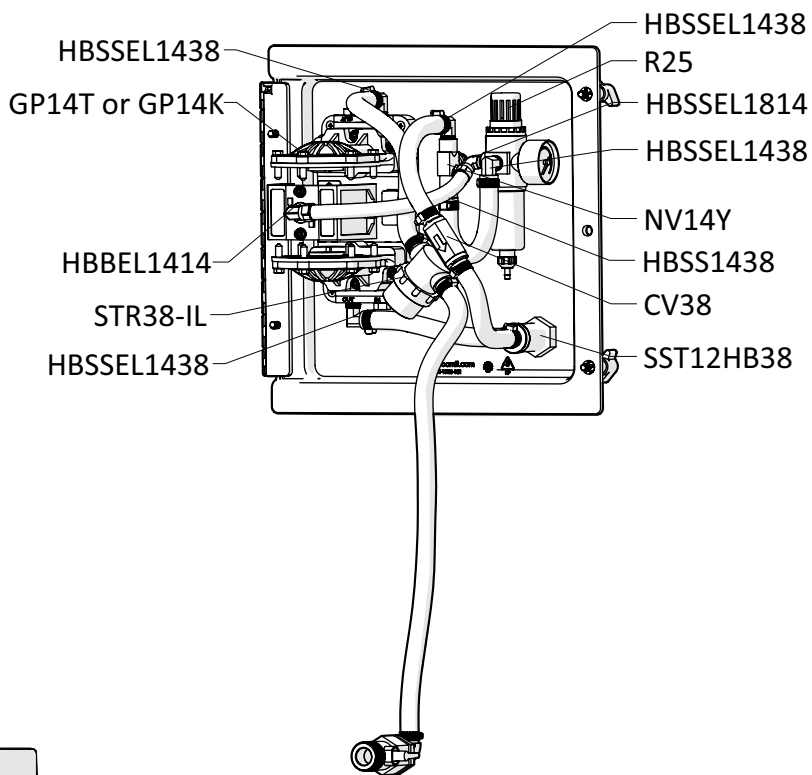
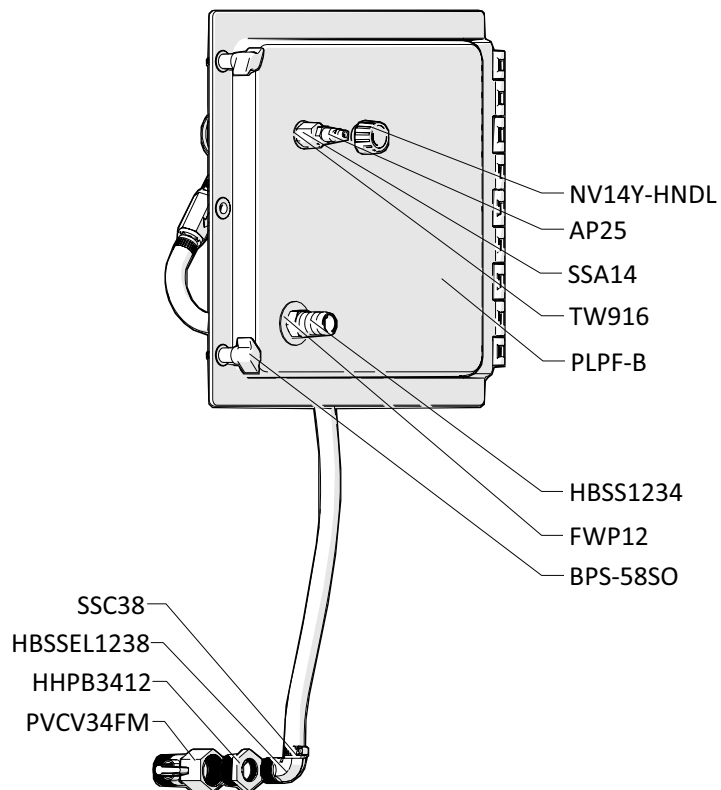

PLATE ASSEMBLY - Back View



READ ALL INSTRUCTIONS BEFORE OPERATING EQUIPMENT

OPTIONAL COMPONENTS

30 ft (9 m) AIR HOSE ASSEMBLY
ITEM NUMBER: AH30

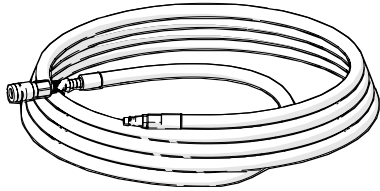

WATER SEPARATOR
ITEM NUMBER: WS-20CFM

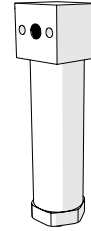

FAN TIP FOAM WAND ASSEMBLY
ITEM NUMBER: PWA34-ST

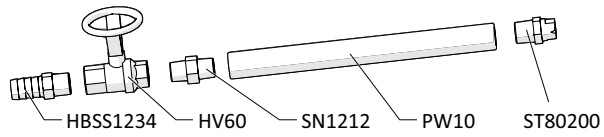

READ ALL INSTRUCTIONS BEFORE OPERATING EQUIPMENT

ITEM NUMBER	DESCRIPTION
AG100	1.5 INCH DRY MODEL 20 DUAL SCALE GAUGE
AP25	PLUG 1/4 NPTM AIR FITTING - BRASS
AS1-VS	1/4-20 X 1/2 PHIL TRUSS MACH SCREW 19-8 W/516 ORANGE VIBRASEAL PATCH
B103278F	10-32 X 7/8 PHIL FLAT MACH SCR 18-8
B8X58	8-15 X 5/8 inch PHIL FLAT TY-A 316 S.S.
BPS-58SO	Back Panel Screw - 5/8 inch with Stand Off
BPS-SSR	1/4 INCH PUSHNUT BOLT RETAINER STAINLESS STEEL
COT	1/8 X 1 COTTER PIN 18-8 S/S
CV38	PVC CHECK VALVE 3/8 BARBS - SS SPRING
DFP7	7 INCH HINGED CAP ASSEMBLY - INCLUDES BLACK CAP, LID FLANGE AND HINGE PIN
<i>DFP7-C</i>	7 INCH FILL CAP POLYPRO BLACK
<i>DFP7-F</i>	7 INCH TANK LID FLANGE POLYPRO
<i>DFP7-PIN</i>	HINGE PIN FOR DFP7-C & DFP7-C
DFP7-C-BL	7 INCH FILL CAP POLYPRO BLUE PANTONE
DFP7-C-GN	7 INCH FILL CAP POLYPRO GREEN PANTONE
DFP7-C-RD	7 INCH FILL CAP POLYPRO RED PANTONE
DFP7-C-YL	7 INCH FILL CAP POLYPRO YELLOW PANTONE
DP-A	DRAIN PLUG ASSEMBLY INCLUDES DRAIN PLUG AND GASKET
<i>DP</i>	FRONT DRAIN PLUG FOR PORTABLE UNIT POLYPRO
<i>DP-G</i>	FKM SQUARE CUT DRAIN PLUG GASKET
DP-INSERT	304 STAINLESS DRAIN PLUG INSERT
EC75	OETIKER CLAMP-12/04/07
F34SS-L	SS CRIPM FERRULE 1.90inches X 1.5 inches LONG
F38SS	STAINLESS 3/8 INCH FERRULE
FACI14	FEMALE COUPLER - 1/4in NPTF
FWAX15	FLAT AXLE WASHER
FWP12	7/8 ID X 1.5 OD X 0.05 THK SSFW
FWP14	C-816 1/2in SS WASHER
GP14K	1/4in GRACO PUMP KYNAR BODY WITH TEFLON DIAPHRAGM
GP14T	1/4in GRACO PUMP POLYPROBODY WITH TEFLON DIAPHRAGM
H14B-H	1/4 INCH BLUE HOSE- GOODYEAR HORIZON - Available per ft.
H34B-H	3/4 INCH BLUE GOODYEAR HORIZON HOSE - Available per ft.
H38B-H	3/8 INCH BLUE GOODYEAR HORIZON HOSE - Available per ft.
HBBEL1414	1/4 MPT X 1/4 HOSE BARB BRASS 90 DEG
HBBF1438	BRASS 1/4in FPT X 3/8in HOSE BARB
HBSS1234	STAINLESS HOSE BARB 1/2 X 3/4
HBSS1438	STAINLESS HOSE BARB 1/4 MPT X 3/8 BARB

HBSS1238	304 S.S. 1/2in MPT BY 3/8in H.B. ELBOW
HBSS1438	STAINLESS HOSE BARB ELBOW 1/4 INCH NPT X 3/8 HOSE BARB
HBSS1814	304 STAINLESS ELBOW 1/8 INCH NPT X 1/4 INCH HOSE BARB
HHPB3412	HEX HEAD POLY REDUCER BUSHING 3/4 X 1/2
HHSB1238	HEX HEAD S.S. REDUCER BUSHING 1/2in X 3/8
HV60	1/2in STAINLESS BALL VALVE - w/ WELDED NUT
NV14Y	FLOW CONTROL VALVE - INCLUDES BLACK KNOB
<i>NV14Y-HNDL</i>	BLACK KNOB NEEDLE VALVE
PLPF-B	BLANK PORTABLE FOAMER PLATE WITH HINGE W/O HOLES
PLPF-PIN	302 STAINLESS PORTABLE PLATE HINGE PIN
PVCV34FM	PVC VALVE 3/4in FPT X 3/4in MPT
R25	AIR REGULATOR INCLUDES AIR FILTER AND BOWL
<i>AFR25</i>	AIR FILTER for R25
<i>ABR25</i>	METAL AIR BOWL for R25
S142058-VS	1/4-20 X 5/8 PHIL TRUSS MACHINE SCREW 18-8 W/#516 VIBRASEAL ORANGE PATCH
SSA14	SS304 MALE/FEMALE ADAPTOR 1/4 NPT X 1/4 NPT
SSAXLE15	STAINLESS STEEL AXLE 15.625 INCHES LONG BY 5/8 INCH IN DIAMETER DRILLED AND BEVELED
SSC38	WORM GEAR CLAMP, S/S (.25-.63)
SSP12	STAINLESS STEEL AXLE PLATE - 2.5 inch X 1 inch - 2 HOLE
SST12HB38	STAINLESS TEE COMBO 1/2in FPT X 3/8 in BARB WITH SSST AND S.S. MESH
<i>SS-MESH</i>	STAINLESS STEEL MESH WITH SSST FOR REPLACEMENT
<i>SSST</i>	SCREEN DISC .687 DIA. 10 X 10 MESH @ .020 DIA. 300 SERIES S.S.
STR38-IL	IN LINE STRAINER 3/8 BARB 20 MESH 304 STAINLESS EDPM GSKT
TANK-20N	20 GALLON NATURAL ROTOMOLDED TANK
TW916	1/2 INT TOOTH L/W 410SS
W15	NONMARKING WHEEL FOR PORTABLE UNITS
W387	S.S. 304 SPRAY WAND 3/8in MPT X 7in LONG - THREAD ON ONE END